

25 WATT SQUARE OFFICE DOWN LIGHT

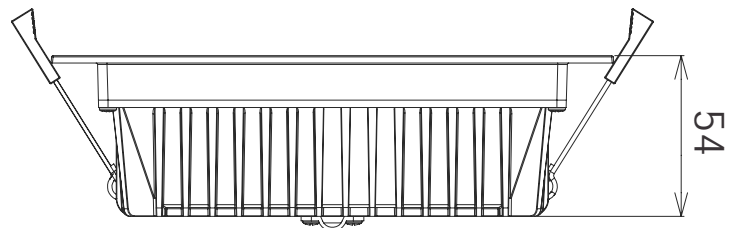

RoHS

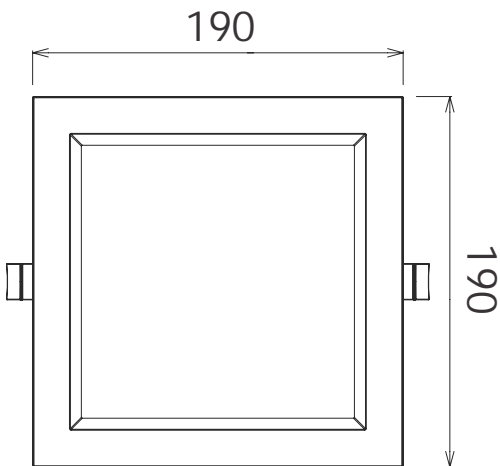

25 WATT SQUARE OFFICE DOWN LIGHT

Technical Specifications

Model	Voltage	Power	Power Factor	Lumen (±5%)	Beam angle	CCT	Lifespan	CRI	Dimmable	Dimension
OFFICE-190-25W	AC90-264V	25W	≥0.9	1858	90°	5000K	40000hs	≥80	Yes	190*190*54mm cutout 160-170mm

Driver data Sheet

Driver data	DIM	Non-dim
Input Voltage	AC200-240V	AC90-264V
Frequency	50Hz	50-60Hz
Input rated Voltage	AC230V	AC100-240V
Efficiency	≥83%	≥83%
No load wattage	≤0.5W	≤0.5W
Total load Wattage	25W±5%	25W±5%
Power Factor	≥0.9	≥0.9
Rated input current	≤0.2A	≤0.3A
No load output Voltage	DC45V	DC45V
No load output Voltage range	DC40-48V	DC40-48V
Full load output Voltage	DC24-36V	DC24-36V
Rated output current	700mA	700mA
Output current range	700mA±5%	700mA±5%
Tolerance	±5%	±5%
Current output tolerance	±5%	±5%
Dimming range	8%-100%	—
Dimmer	Triac dimmers	—
Withstand voltage	AC3750V	AC3750V

Rated Wattage	Electrical Classification	Ingress Protection (IP)	Operating Temp	Operating Humidity	Storage Temp
25W	III	20	-10°C-45°C	0-90%	-20°C-65°C

Spectral Distribution

OFFICE-190-25W

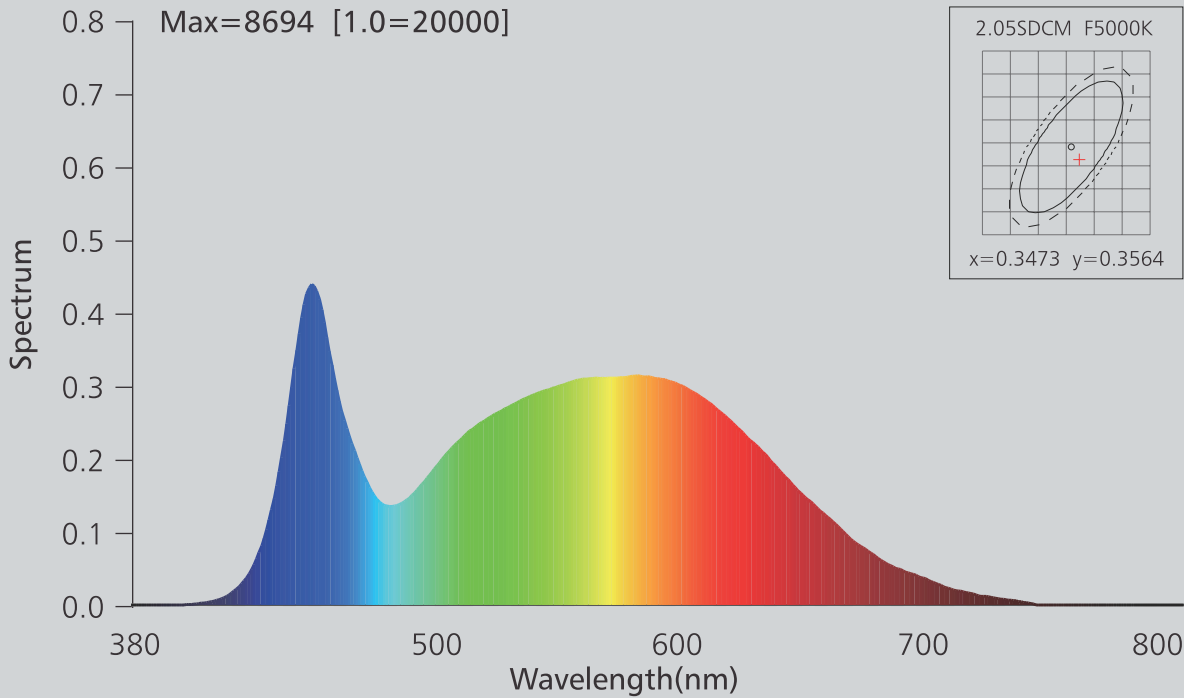

Photometric Diagram

OFFICE-190-25W

Polar intensity diagram

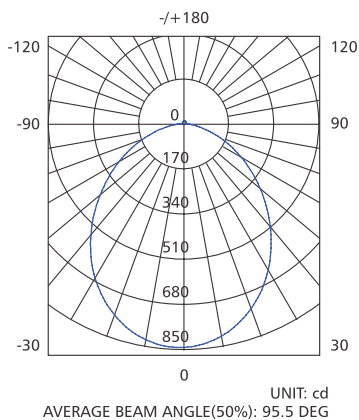

Cartesian intensity diagram

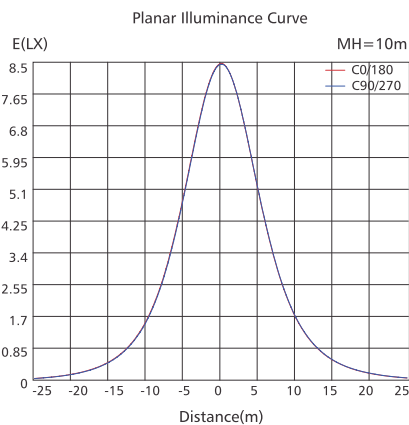

Beam diagram

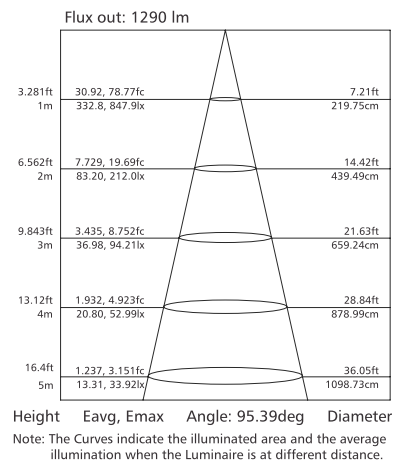

25 WATT SQUARE OFFICE DOWN LIGHT

Installation

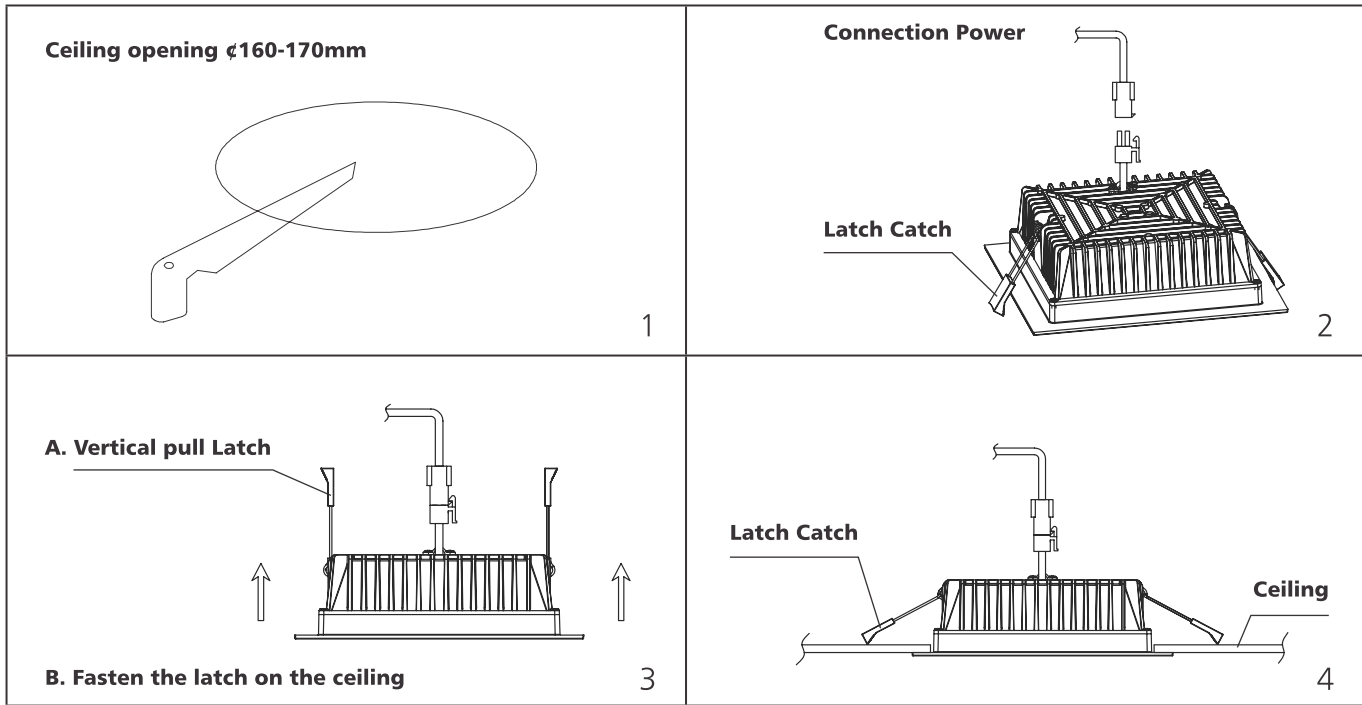

25 WATT SQUARE OFFICE DOWN LIGHT