

LED LIGHTING AUSTRALIA- 100W-LED STREET LIGHT Specification

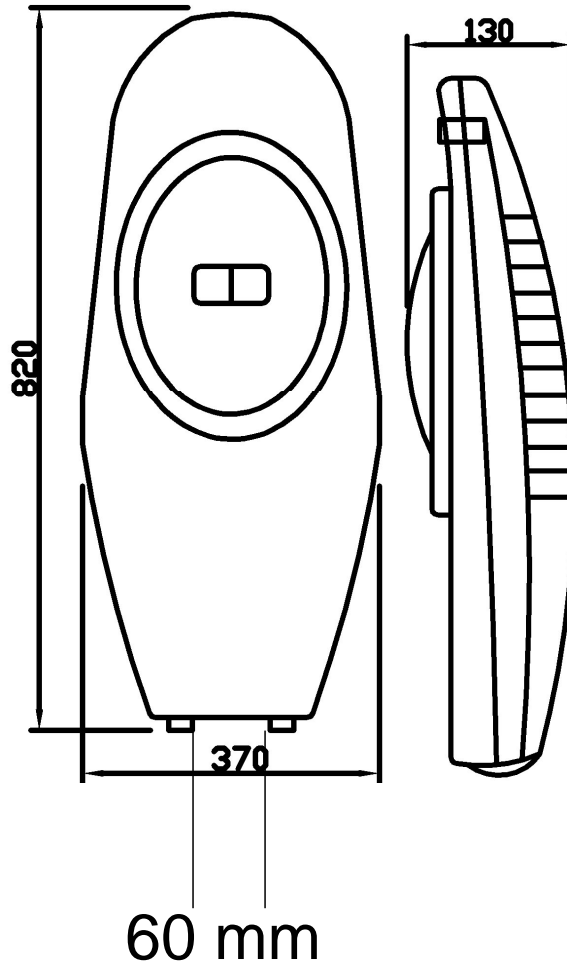

Product Size



Application :

Main Road , Sidewalk , Square , School , Park , Garden , Factory , Residential Places , Villa and many other projector lighting places.

Main Parameters :

- Input Voltage AC90-295V,47-63Hz
- LED QTY:2 x (50 x 1W)
- Total Power 108W±2W
- Power Factor(PF): >0.95
- Driver Efficiency >91%
- LED Efficiency >90 lm/w
- Initial LED Lumen >9000 lm
- LED Work Voltage 30-34V
- Related color temperature(CCT)
Cool White: 6000-7000K , Pure White : 4500 – 5500K , Warm White : 3000 – 4000K
- IP Rating: IP65
- Working Temperature -40 °C ~ 50 °C
- Working Humidity -10 ~ 90%RH
- Storage Temperature -50 °C ~65 °C
- Material Die casting aluminum, Aluminium Reflector and toughened glass
- LED Lifespan > 50,000 hours
- Pole diameter 60mm